

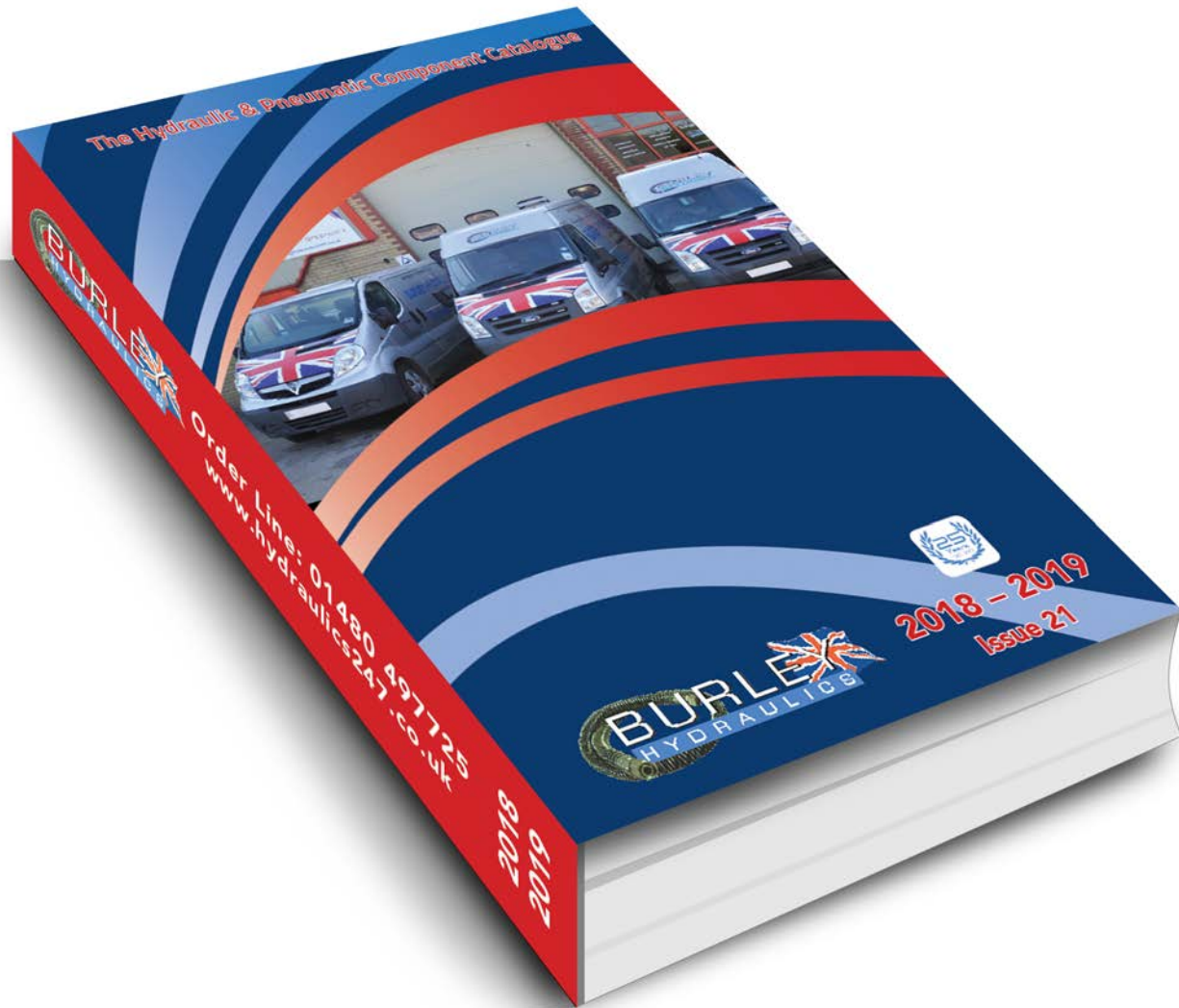

BURLEY

HYDRAULICS

New catalogue



New brands

FastTest[®]
Your Connection Experts

Alusic

***Master
Lock***[®]

PV[▽]L
Engineers Supplying Engineers

AV *Automatic
Valve*

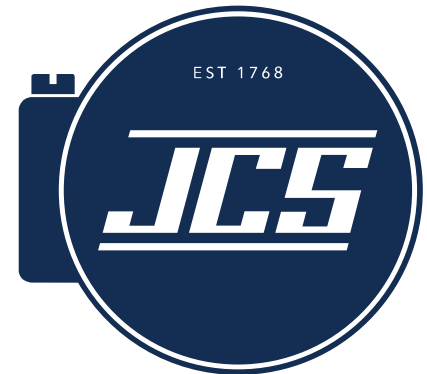

New products



BURNETT & HILLMAN
HYDRAULIC ADAPTOR UK MANUFACTURER



PARKAIR



FESTO



Connecting Technology

Redashe



New line additions



BURNETT & HILLMAN
HYDRAULIC ADAPTOR UK MANUFACTURER

PARKAIR[®]



MIKALOR

FESTO

PARKAIR®

SWING COUPLINGS (19 SERIES)

PAGE 27

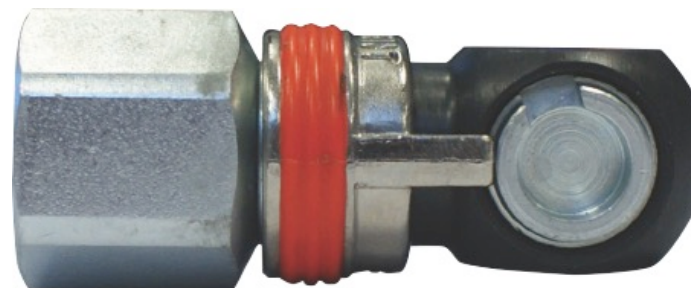
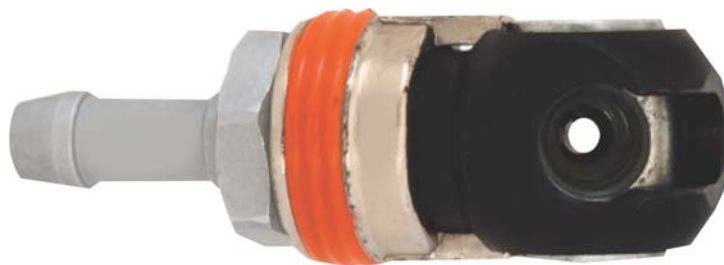
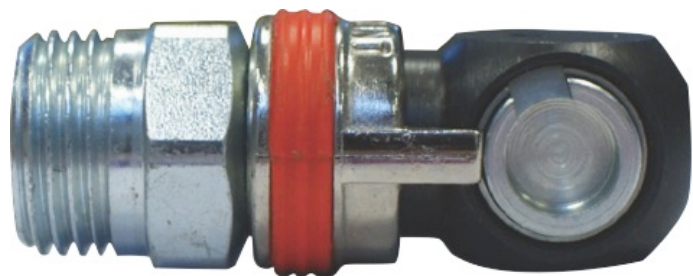



LQ2 SERIES CONNECTORS PAGES 54-55



DTLD SERIES CONNECTORS PAGE 61

PARKAIR®

SWIVEL JOINTS
CARBON STEEL & STAINLESS STEEL
PAGE 238



PARKAIR®

SPILL ABSORBENTS
PAGE 288



PARKAIR®

A close-up photograph of a green tractor's hydraulic system. The image shows several black hoses wrapped in a black, segmented spiral guard. The hoses are connected to various components, including a silver metal fitting and a black hose with a textured grip. The background is a grassy field.

SPIRAL GUARD
PAGE 290

PARKAIR®

SERVICE PLUGS
PAGE 291



PARKAIR®

PRESSURE WASHER HOSE
PAGES 292-294





E·MC[®]

SOLENOID VALVES
PAGES 316, 318-320





FILTER, REGULATOR, LUBRICATOR & ISOLATION VALVE ASSEMBLY
PAGE 335

PAGES 392-425

FESTO BLUE STAR RANGE

Festo, the leading supplier of automation equipment, now offers more than 2,200 blue star core products for pneumatics, including cylinders, valves, regulators, sensors and accessories, as well as products that meet the specific requirements of process automation. These include solenoid, NAMUR and angle seat valves, positioners, sensor boxes, ball valves and ball valve actuator units, products for air preparation and accessories.

WHY SO SPECIAL?

Festo's state of the art production facilities ensure that all of the products highlighted with the blue star are of superb quality at attractive prices, as well as having excellent delivery times, even in high quantities. Great news for machine builders and buyers!

WHAT TO LOOK FOR

Look for the Blue Star symbol throughout this section of the catalogue.



FESTO

FESTO BLUE STAR RANGE

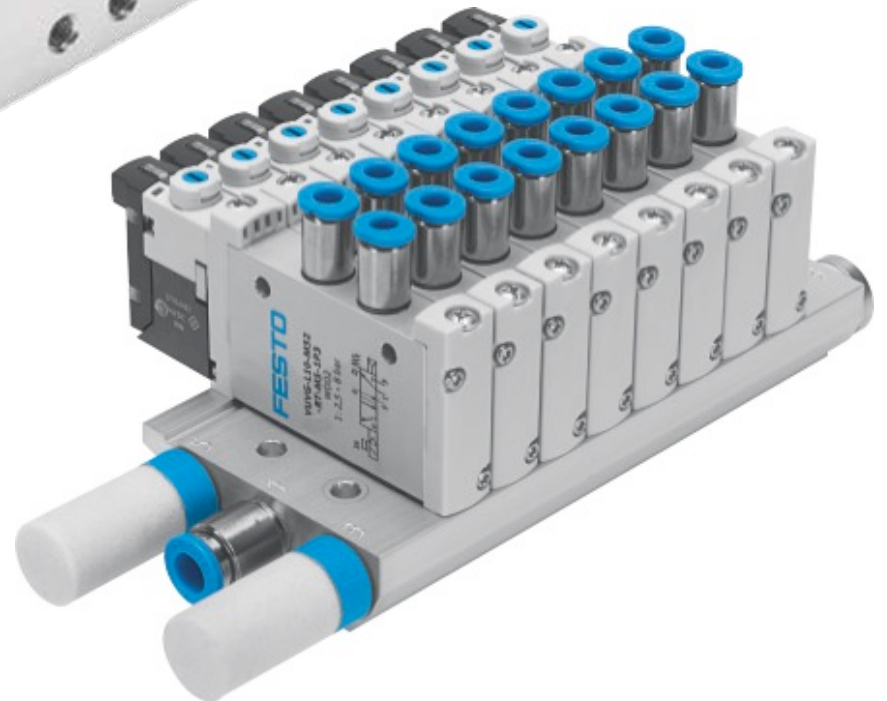

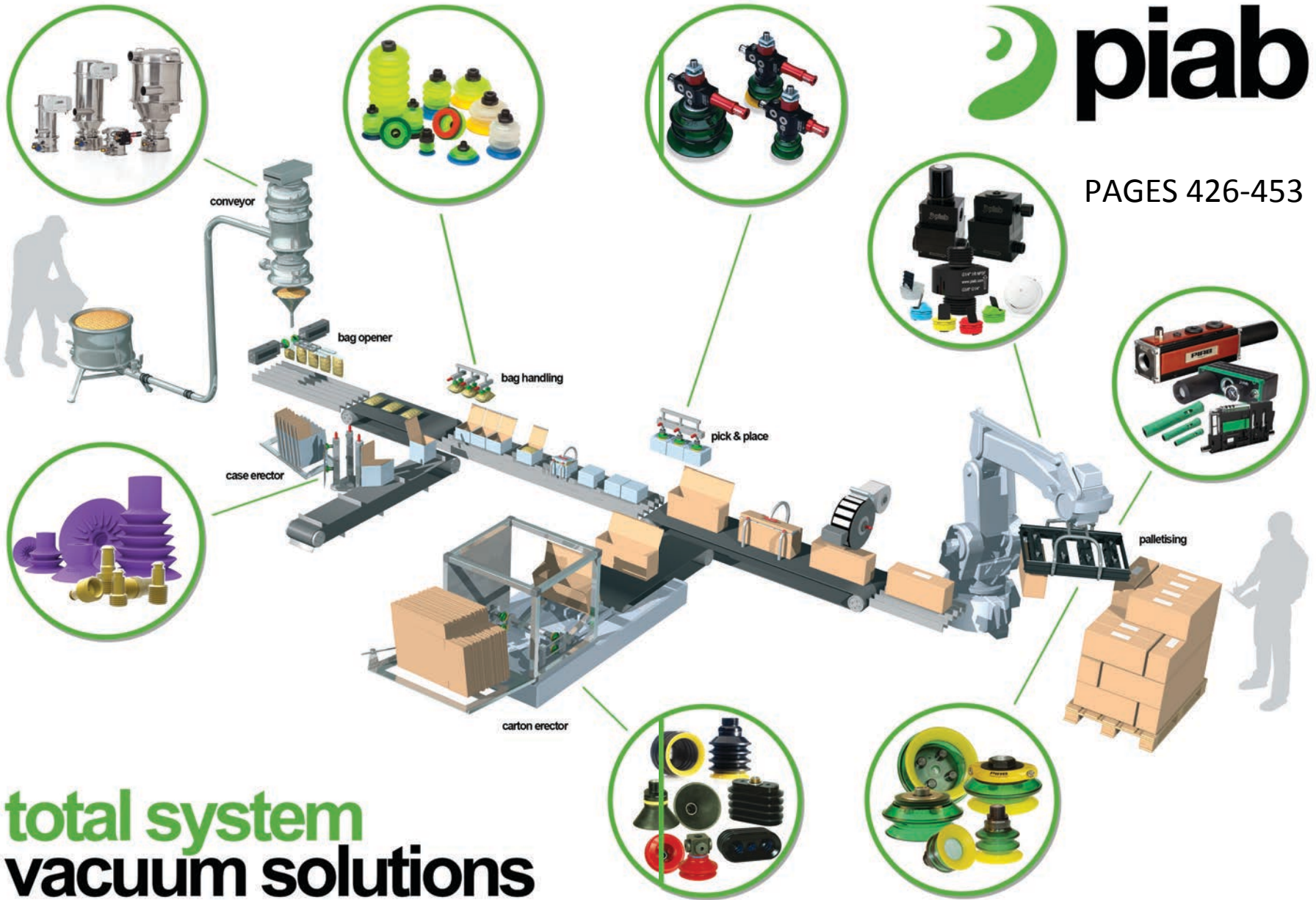

**total system
vacuum solutions**

PARKAIR®

HI VIZ HOSE
PAGE 464



TRICOFLEX

FLEXIBLE BRAIDED PVC HOSE
PAGE 465



PARKAIR®

FUEL HOSE FITTINGS & ACCESSORIES
PAGES 502-503



PARKAIR®

FIRE HOSE REELS, HOSE & ACCESSORIES
PAGES 524-527









PARKAIR®

BRASS HOSETAIL NPT MALE – UNPLATED
PAGES 606-607

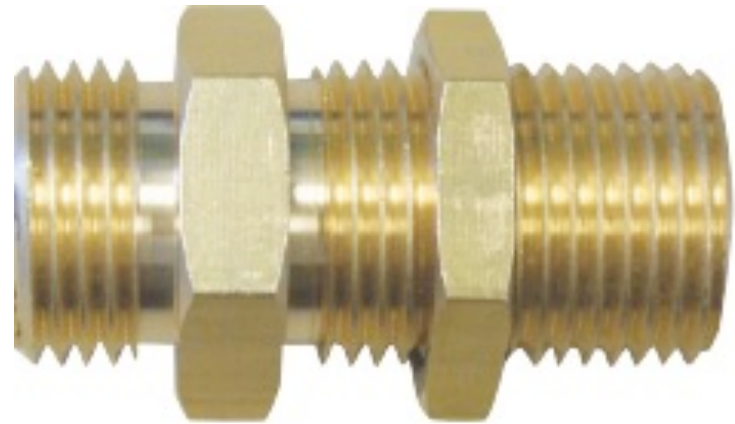

PARKAIR®



BRASS NICKEL PLATED PUSH-IN FITTINGS
PAGE 626

PARKAIR®

STAINLESS STEEL FLANGES
PAGE 699



PARKAIR®

STAINLESS STEEL PUSH-IN FITTINGS
PAGE 700



PARKAIR®

STAINLESS STEEL BALL VALVES
PAGE 705



PARKAIR®

STAINLESS STEEL FILTERS,
REGULATORS & VALVES
PAGES 716-717





PARKAIR®

PRESSURE RELIEF VALVES
PAGE 761

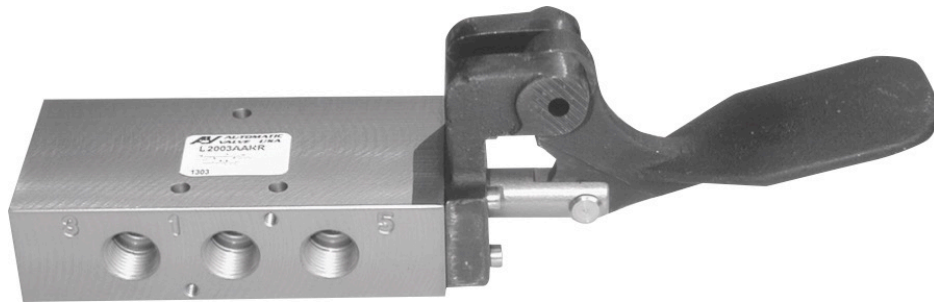

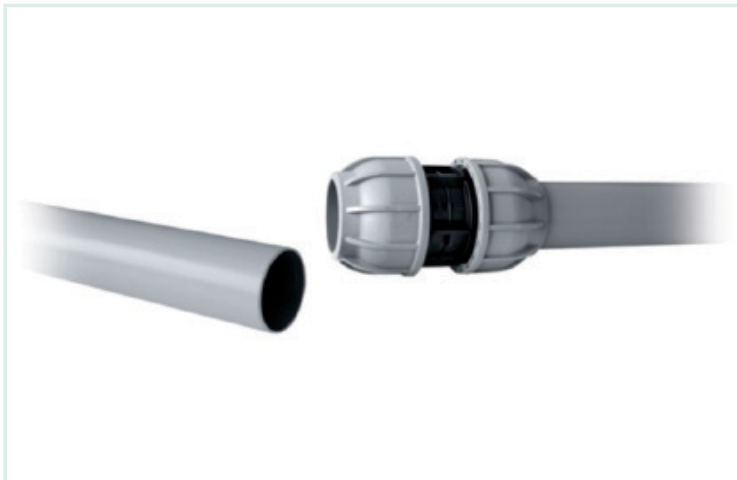



ALUMINIUM COMPRESSED AIR SYSTEM
PAGES 782-783

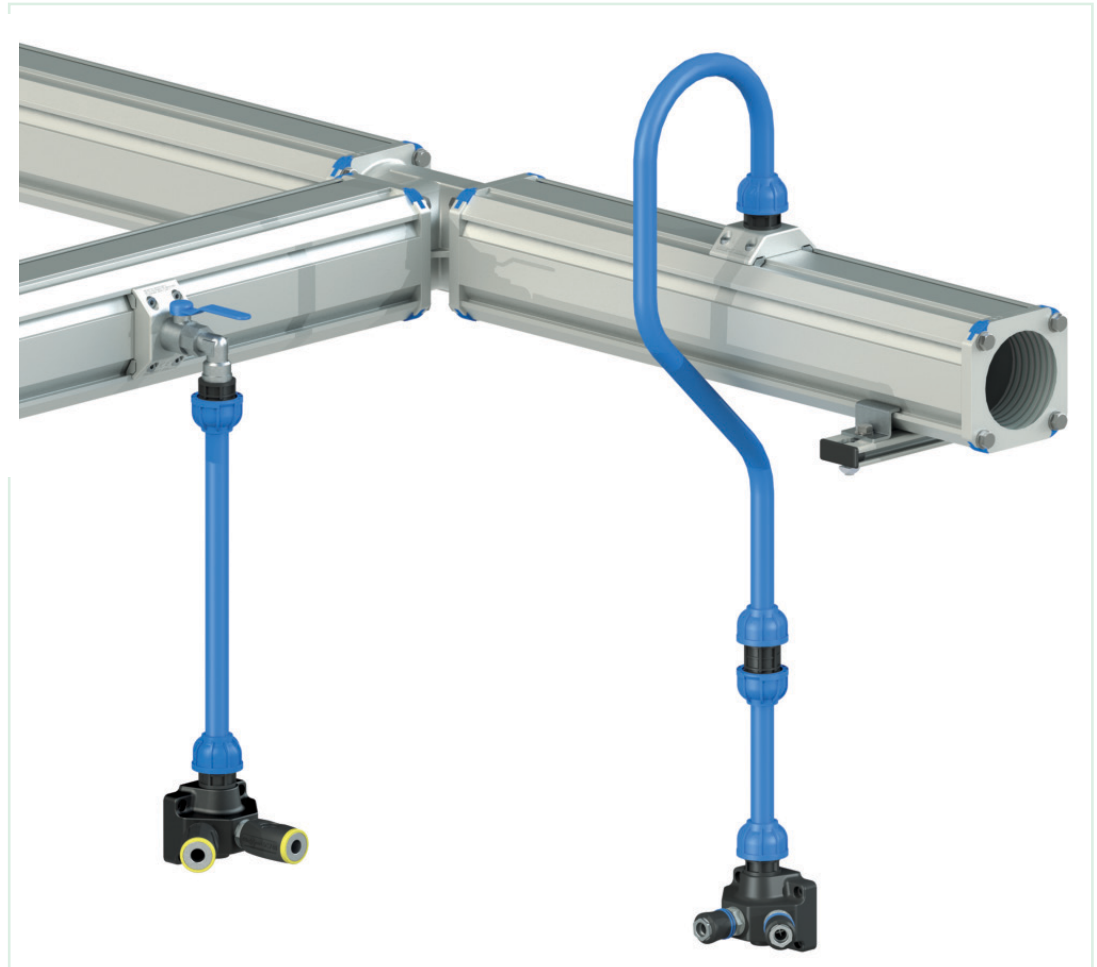

Alusic

ALUMINIUM PROFILES
PAGES 789-792

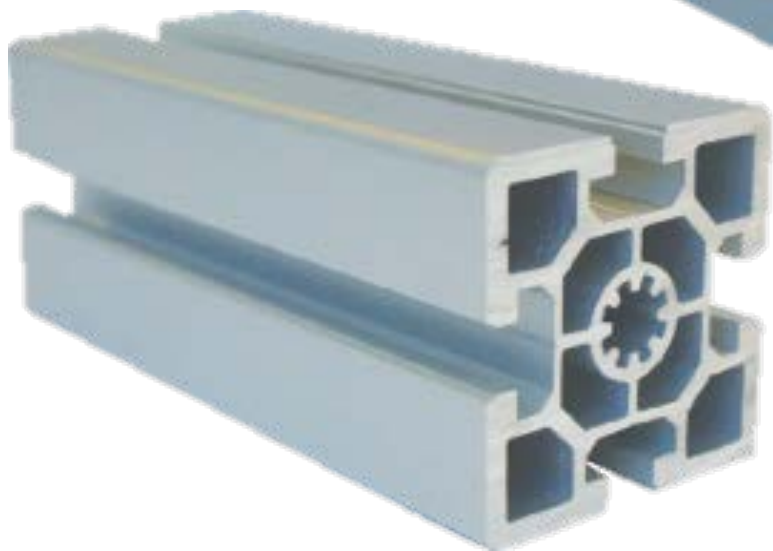
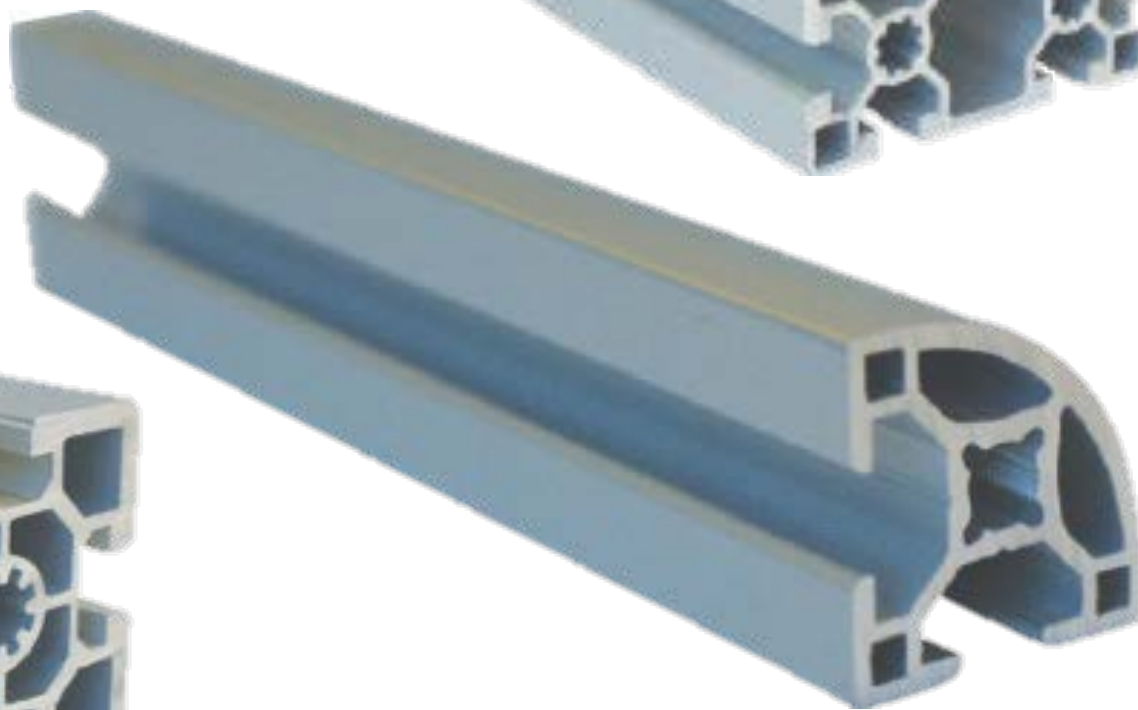
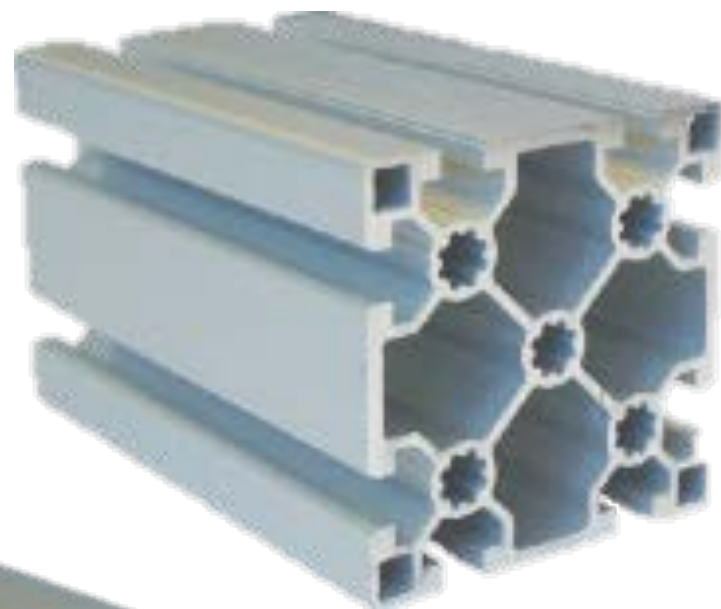

PARKAIR®

FLANGES & GASKETS
PAGES 816-817





WORM DRIVE & WING SCREW HOSE CLIPS
PAGE 850

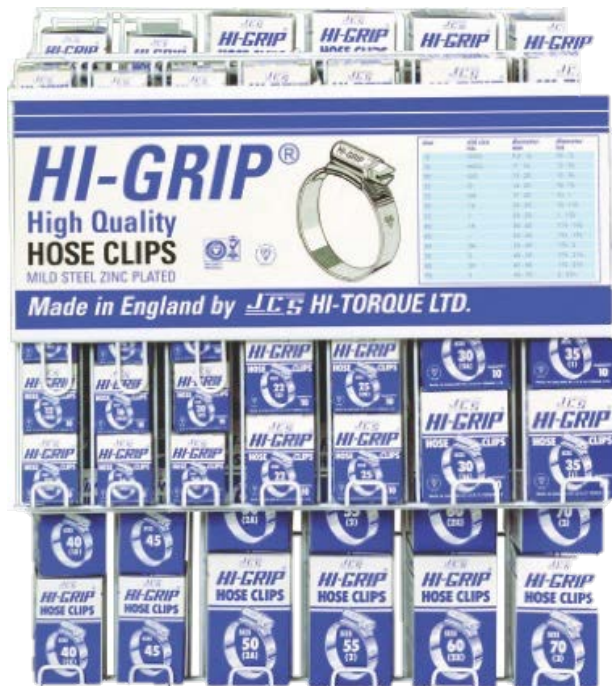

PARKAIR®

SIGHT FLOW INDICATORS
PAGES 866-868







SAFETY HOSE REELS
PAGE 894



PARKAIR®

AIR RECEIVERS
PAGE 955



PARKAIR®



CABLE TIES, HEAT SHRINK & TAPE
PAGE 980-981

Master Lock®

PADLOCKS &
SAFETY LOCKOUT SYSTEMS
PAGES 999-1003



FastTest[®]
Your Connection Experts

QUICK CONNECTORS FOR LEAK,
PRESSURE & PERFORMANCE TESTING
PAGES 1006-1015





**THANK YOU
FOR YOUR ATTENTION**